

DISPO-MED[®]

Leading in Design and Innovation

Manufacturer of EtCO₂ Cannulas and Accessories

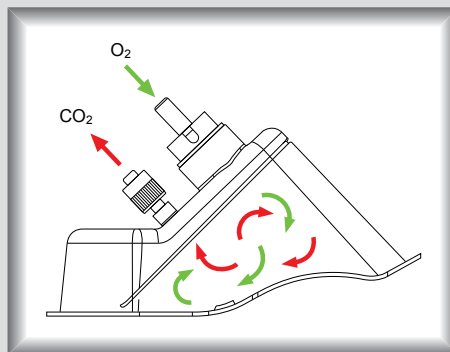
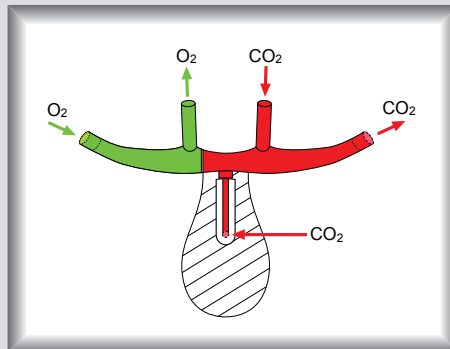
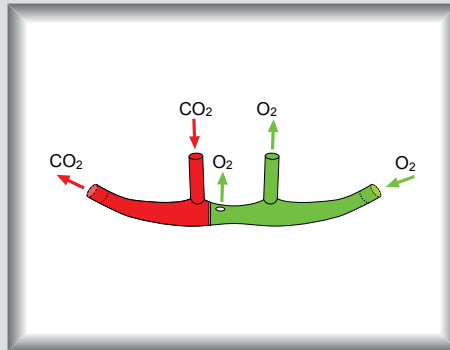

National Mark of
Malaysian Brand



SME Competitiveness
Rating For Enhancement

About Us

Dispo-Med (Malaysia) Sdn Bhd was established in 1997 and specialises in Dipping Technology, with special focus on capnography products.

Dispo-Med is a leading manufacturer of EtCO₂ Cannula, with the widest and most comprehensive range of designs.

Our commitment to design and development in capnography products has resulted in numerous patents in EtCO₂ cannulas worldwide.

Today, Dispo-Med products are exported worldwide, including USA, China, Australia, Europe and Middle East.



N.C. Leow, Founder / CEO of Dispo-Med

Vision & Mission

VISION

Leading in design and innovation.

MISSION

We are dedicated to improving patient care with innovative Dip Molded Nasal Cannulas of superior quality.

Patents



Patented Worldwide



Milestones & Achievements

Global Standard



US FDA 510K



CE Mark



ISO13485:2016

Malaysia



Malaysia Medical Device Authority



SME Competitiveness Rated ★★★★★



National Mark of Malaysian Brand





Dipping Technology



Manufacturing Facility

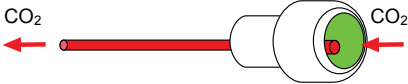
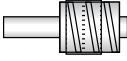
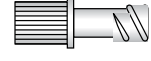
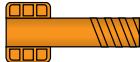

CO₂ Cannulas

PRODUCT	CONNECTOR	CODE	SIZE
 <p>SINGLE PORT EMERGENCY NASAL CO₂ CANNULA</p> <p>CO₂ Tubing Length: 2.1M</p> 	 Male luer lock	DM-1000-AM	Adult
	 Female luer lock	DM-1000-AF	Adult
	 Input Connector	DM-1000-AST	Adult With 0.2um Filter

CO₂ Sampling and O₂ Delivery Mask

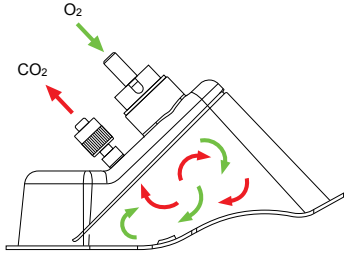
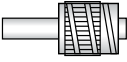
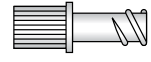
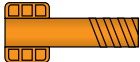
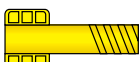
PRODUCT	CONNECTOR	CODE	SIZE
 <p>CAPNOMASK O₂ + CO₂ SAMPLING MASK</p>  <p>CO₂ Tubing Length: 2.1M O₂ Tubing Length: 2.1M</p>	 Male luer lock	CO2-MAS-AM CO2-MAS-PM	Adult Paediatric With 0.2um Filter
	 Female luer lock	CO2-MAS-AF CO2-MAS-PF	Adult Paediatric With 0.2um Filter
	 Input Connector	CO2-MAS-AST CO2-MAS-PST	Adult Paediatric With 0.2um Filter
	 Input Connector	CO2-MAS-ALT CO2-MAS-PLT	Adult Paediatric With 0.2um Filter and Dryer

CO₂ Sampling Line

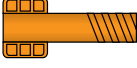
PRODUCT	CONNECTOR	CODE
 <p>CO₂ SAMPLING LINE WITH FILTER</p> <p>CO₂ Tubing Length: 3.0M</p>	 <p>Input Connector</p>	DM-7100/CO-10FTST

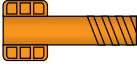
PRODUCT	CONNECTOR	CODE
 <p>CAPNOGRAPHY ADAPTER The Capnography Adapter is intended to connect Microstream™ enable monitors with standard male luer lock connector End-tidal CO₂ (EtCO₂) monitor devices</p> <p>CO₂ Tubing Length: 6" inch</p>	 <p>Input Connector</p>	DM-7100/CO-6"STM

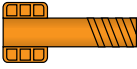

PRODUCT	CONNECTOR	CODE
 <p>CAPNOGRAPHY ADAPTER The Capnography Adapter is intended to connect Microstream™ enable monitors with standard female luer lock connector End-tidal CO₂ (EtCO₂) monitor devices</p> <p>CO₂ Tubing Length: 6" inch</p>	 <p>Input Connector</p>	DM-7100/CO-6"STF

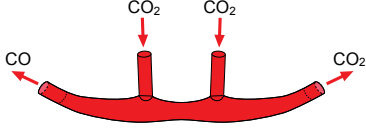
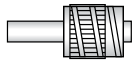
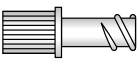
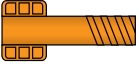
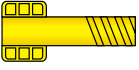
CO₂ Cannulas

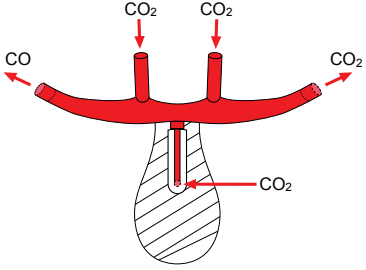
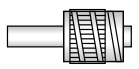
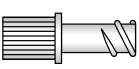
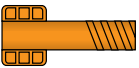
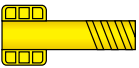
PRODUCT	CONNECTOR	CODE	SIZE
 <p>NASAL CO₂ SAMPLING CANNULA</p>  <p>CO₂ Tubing Length: 2.1M</p>	 Male luer lock	DM-4100-AM DM-4100-PM	Adult Paediatric
	 Female luer lock	DM-4100-AF DM-4100-PF	Adult Paediatric
	 Input Connector	DM-4100-AST DM-4100-PST	Adult Paediatric <i>With 0.2um Filter</i>
	 Input Connector	DM-4100-ALT DM-4100-PLT	Adult Paediatric <i>With 0.2um Filter and Dryer</i>

PRODUCT	CONNECTOR	CODE	SIZE
 <p>LO-FLO NASAL/ORAL CO₂ SAMPLING CANNULA</p>  <p>CO₂ Tubing Length: 2.1M</p>	 Male luer lock	DM-2601/LO-AM DM-2601/LO-PM	Adult Paediatric
	 Female luer lock	DM-2601/LO-AF DM-2601/LO-PF	Adult Paediatric
	 Input Connector	DM-2601/LO-AST DM-2601/LO-PST	Adult Paediatric <i>With 0.2um Filter</i>
	 Input Connector	DM-2601/LO-ALT DM-2601/LO-PLT	Adult Paediatric <i>With 0.2um Filter and Dryer</i>

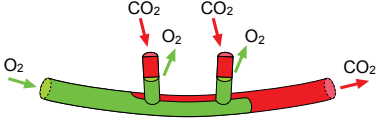
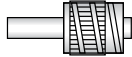
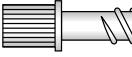
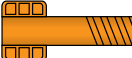
CO₂ Cannulas

PRODUCT	CONNECTOR	CODE	SIZE
 <p>DUO FLOW O₂ + CO₂ SAMPLING CANNULA</p>  <p>CO₂ Tubing Length: 2.1M O₂ Tubing Length: 2.1M</p>	 Male luer lock	DM-6500-AM DM-6500-PM	Adult Paediatric
	 Female luer lock	DM-6500-AF DM-6500-PF	Adult Paediatric
	 Input Connector	DM-6500-AST DM-6500-PST	Adult Paediatric <i>With 0.2um Filter</i>
	 Input Connector	DM-6500-ALT DM-6500-PLT	Adult Paediatric <i>With 0.2um Filter and Dryer</i>

Product Features

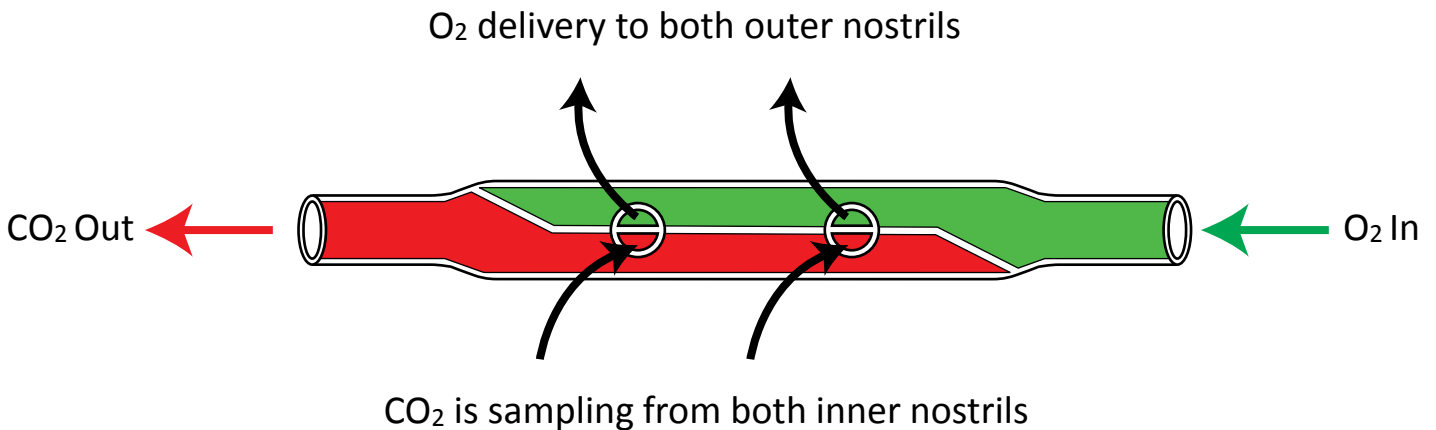

This unique design of EtCO₂ nasal cannula

- able to sampling EtCO₂ and delivery of O₂ from both nostril simultaneously
- minimize dilution of waveform when O₂ is delivered to both nostrils

Fact Sheet:

- ✓ Made of DEHP free PVC material and Latex Free
- ✓ Works with any side-stream monitor with low flow 50ml/min

CO₂ Cannulas

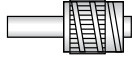
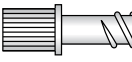
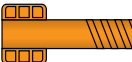
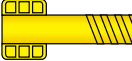
PRODUCT	CONNECTOR	CODE	SIZE
 <p>NASAL CO₂ SAMPLING CANNULA W/O₂ DELIVERY</p> <p>CO₂ Tubing Length: 2.1M O₂ Tubing Length: 2.1M</p>	 Male luer lock	DM-4000-AM DM-4000-PM	Adult Paediatric
	 Female luer lock	DM-4000-AF DM-4000-PF	Adult Paediatric
	 Input Connector	DM-4000-AST DM-4000-PST	Adult Paediatric <i>With 0.2um Filter</i>
	 Input Connector	DM-4000-ALT DM-4000-PLT	Adult Paediatric <i>With 0.2um Filter and Dryer</i>

Product Features Dip Molded Nasal Cannula

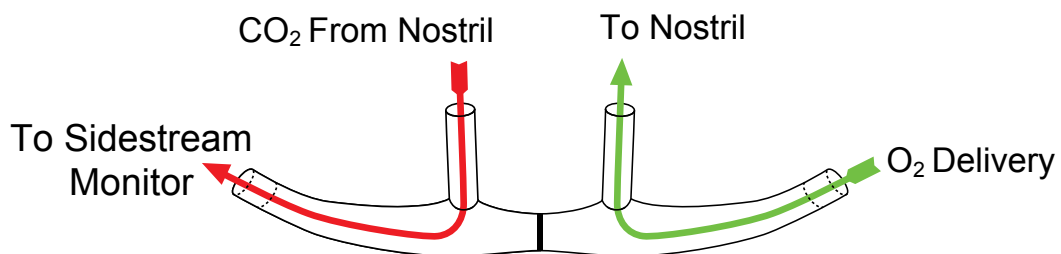

This unique design of EtCO₂ nasal cannula

- EtCO₂ sampling at one nostril
- O₂ delivery to another nostril

CO₂ Cannulas

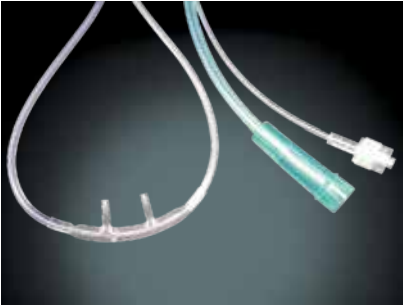
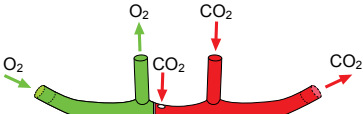
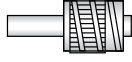
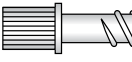
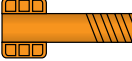
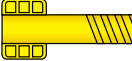
PRODUCT	CONNECTOR	CODE	SIZE
 <p>NASAL DUAL CO₂ SAMPLING CANNULA W/O₂ DELIVERY</p>  <p>CO₂ Tubing Length: 2.1M O₂ Tubing Length: 2.1M</p>	 Male luer lock	DM-4401-AM	Adult
	 Female luer lock	DM-4401-AF	Adult
	 Input Connector	DM-4401-AST	Adult <i>With 0.2um Filter</i>
	 Input Connector	DM-4401-ALT	Adult <i>With 0.2um Filter and Dryer</i>

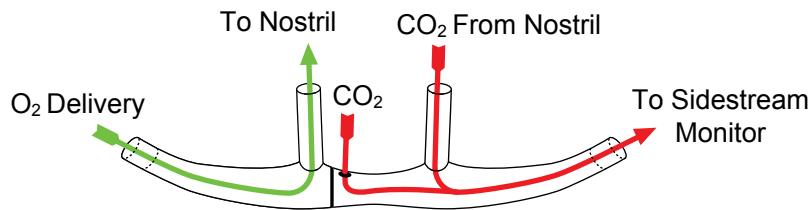

This unique design allows sampling of EtCO₂ from both nostrils

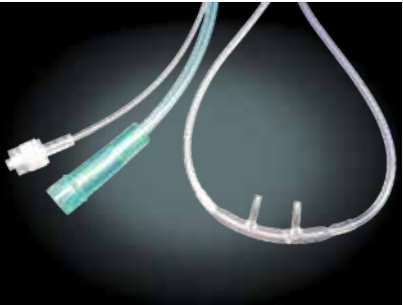
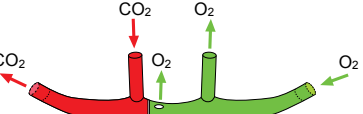
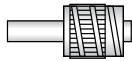
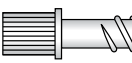
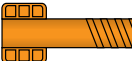
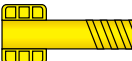

- ✓ EtCO₂ is sampling from one inner nostril and other outer nostril simultaneously
- ✓ Dip Molded nasal prong made of phthalate free PVC material and Latex Free
- ✓ Tubing made of DEHP free PVC material and Latex Free
- ✓ Work with any side-stream monitor with Low Flow 50ml/min.

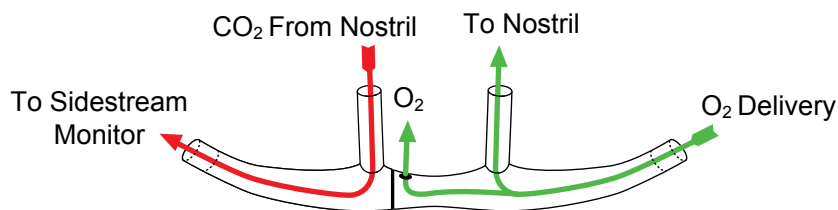
PRODUCT	CONNECTOR	CODE	SIZE
 <p>LO-FLO CO₂ SAMPLING CANNULA W/DUAL O₂ DELIVERY</p>  <p>CO₂ Tubing Length: 2.1M O₂ Tubing Length: 2.1M</p>	 Male luer lock	DM-4441-AM	Adult
	 Female luer lock	DM-4441-AF	Adult
	 Input Connector	DM-4441-AST	Adult <i>With 0.2um Filter</i>
	 Input Connector	DM-4441-ALT	Adult <i>With 0.2um Filter and Dryer</i>

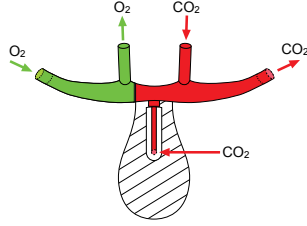
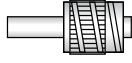
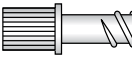

This unique design feature an innovative delivery of O₂ into one inner nostril and other outer nostril simultaneously

CO₂ Cannulas

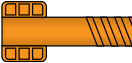
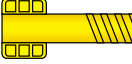
PRODUCT	CONNECTOR	CODE	SIZE
 <p>NASAL/ORAL DUAL CO₂ SAMPLING CANNULA W/O₂ DELIVERY WITH NAFION DRYER</p> 	 Male Luer lock	DM-4601-AM DM-4601-PM	Adult Paediatric
	 Female Luer lock	DM-4601-AF DM-4601-PF	Adult Paediatric
 <p>NASAL/ORAL DUAL CO₂ SAMPLING CANNULA W/O₂ DELIVERY</p> <p>CO₂ Tubing Length: 2.1M O₂ Tubing Length: 2.1M</p>	 Input Connector	DM-4601-AST DM-4601-PST	Adult Paediatric <i>With 0.2um Filter</i>
	 Input Connector	DM-4601-ALT DM-4601-PLT	Adult Paediatric <i>With 0.2um Filter and Dryer</i>

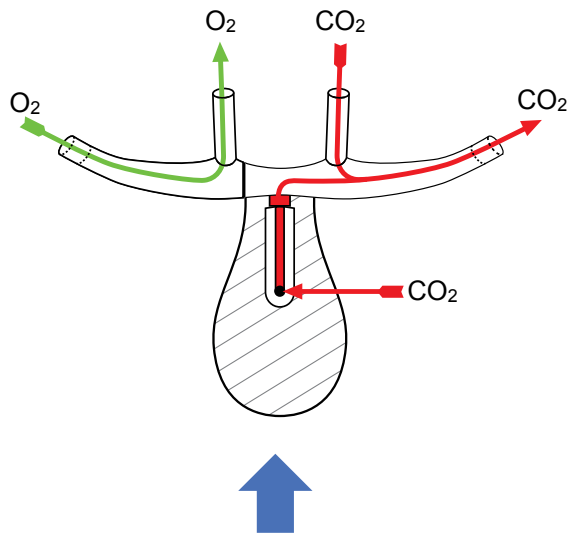





This unique design feature an innovative sampling of EtCO₂ with one nostril and simultaneously oral sampling EtCO₂

Fact Sheet:

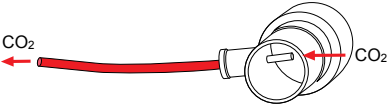
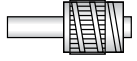
- ✓ Dip molded nasal prong made of phthalate free material and Latex Free
- ✓ Work with any side-stream monitor with Low Flow 50ml/min.

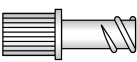
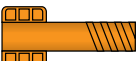
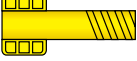
CO₂ Sampling Airway Adapter

PRODUCT	CONNECTOR	CODE	SIZE
 <p data-bbox="536 331 916 439">ALL PURPOSE SAMPLING LINE WITH T CONNECTOR, FILTER, AND NAFION DRYER</p> 	 <p data-bbox="986 439 1123 465">Male luer lock</p>	DM-7700-M	Adult (22/15mm)
 <p data-bbox="536 757 890 864">ALL PURPOSE SAMPLING LINE WITH T CONNECTOR, FILTER</p> <p data-bbox="536 1122 810 1149">CO₂ Tubing Length: 2.1M</p>	 <p data-bbox="986 663 1123 689">Female luer lock</p>	DM-7700-F	Adult (22/15mm)
	 <p data-bbox="986 887 1123 913">Input Connector</p>	DM-7700-ST	Adult (22/15mm) <i>With 0.2um Filter</i>
	 <p data-bbox="986 1111 1123 1137">Input Connector</p>	DM-7700-LT	Adult (22/15mm) <i>With 0.2um Filter and Dryer</i>

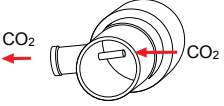
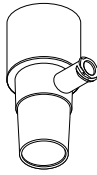
PRODUCT	CONNECTOR	CODE	SIZE
 <p data-bbox="536 1451 858 1518">AIRWAY ADAPTER ONLY (With female luer lock)</p> 	 <p data-bbox="986 1753 1123 1780">Female luer lock</p>	DM-7700-T	Adult (22/15mm)



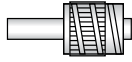
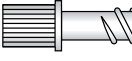
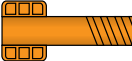
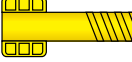

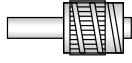
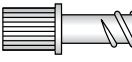

CO₂ Sampling Line

PRODUCT	CONNECTOR	CODE	SIZE
 <p>CO₂ SAMPLING LINE</p> <p>CO₂ Tubing Length: 2.1M</p>	 Male luer lock	DM-7100/CO-M	
	 Female luer lock	DM-7100/CO-F	
	 Input Connector	DM-7100/CO-ST	<i>With 0.2um Filter</i>
	 Input Connector	DM-7100/CO-LT	<i>With 0.2um Filter and Dryer</i>

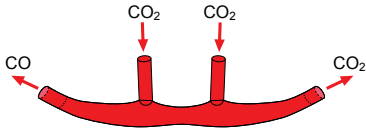
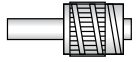
Anaesthetic Gas Sampling Line

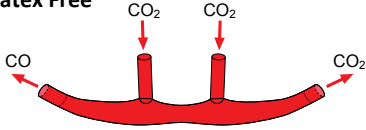
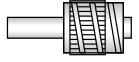
PRODUCT	CONNECTOR	CODE	SIZE
 <p>ANAESTHETIC GAS SAMPLING LINE CO-EXTRUDED PVC/PE TUBE</p> <p>Tubing Length: 3.0M or Request</p>	 Male luer lock	DM-7100-10 FTM	
	 Female luer lock	DM-7100-10 FTF	

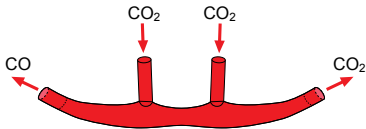
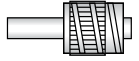
Sleep Diagnostics

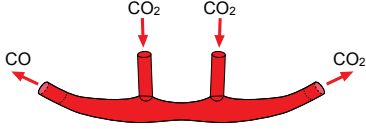
PRODUCT	CONNECTOR	CODE	SIZE
 <p>ALL PURPOSE SAMPLING CANNULA Soft tip, over ear style. Medical Grade PVC – Non-DEHP. Latex Free</p>  <p>Tube Length: 2.1M Optional: with Filte</p>	 Male luer lock	DM-2601-AM DM-2601-PM	Adult Paediatric
 <p>DUAL CO₂/PRESSURE TRANSDUCER SAMPLING CANNULA Disposable nasal airway equipped with soft PVC material, easy of access to the nasal Soft tip, over ear style. Medical Grade PVC – Non-DEHP. Latex Free</p>  <p>Tube Length: 2.1M</p>	 Male luer lock	DM-5500-M DM-5500-F	Adult Paediatric/ Child
 <p>NASAL PRESSURE CANNULA (Compatible with EMBLA®) Soft tip, over ear style. Medical Grade PVC – Non-DEHP. Latex Free</p>  <p>Tube Length: 38cm (DM-142-38) Tube Length: 196cm (DM-142-196)</p>	 Male luer lock	DM-142-38 DM-142-196	Adult Adult
 <p>ALL PURPOSE SAMPLING CANNULA with Filter Soft tip, over ear style. Medical Grade PVC – Non-DEHP. Latex Free</p>  <p>Tube Length: 2.1M Optional: with 0.2 micron Filter</p>		DM-3100-AM (T) DM-3100-PM (T)	Adult Paediatric/ Child

Global Networks



Headquarters

Dispo-Med (Malaysia) Sdn Bhd (418692-X)

No. 3, Jalan Meteor U16/153A, Elmina,
Seksyen U16, 40160 Shah Alam,
Selangor Darul Ehsan,
Malaysia.

Tel : +603-6730 4966 / +603-6730 5466

E-mail : info@dispo-med.com.my

Website : www.dispo-med.com.my